

SERVICE

If the instrument fails to operate, check battery, fuse(s), leads, etc. and replace as necessary. If the instrument still does not operate, double check operating procedure as described in the instruction manual. If the instrument still malfunctions, place it with packing slip along with a brief description of the problem in sufficient cushioning material in a shipping carton. Be sure to indicate the serial number located on the back of the instrument. Amprobe is not responsible for damage in transit. Make certain your name and address also appears on the box as well as packing slip; Ship prepaid via U.P.S. (where available) or Air Parcel Post insured to :

Service Division
 AMPROBE INSTRUMENT
 630 Merrick Road (use for U.P.S.)
 P.O.Box 329 (use for Parcel Post)
 Lynbrook, NY 11563-0329

Outside the U.S.A. the local Amprobe representative will assist you.



AMPROBE
 A United Dominion Company

630 Merrick Road, Lynbrook, NY 11563
 Phone: (516) 593-5600
 Fax: (516) 593-5682
 Tech Support: (800) 477-8658 (VOLT)
 Web: <http://www.amprobe.com>

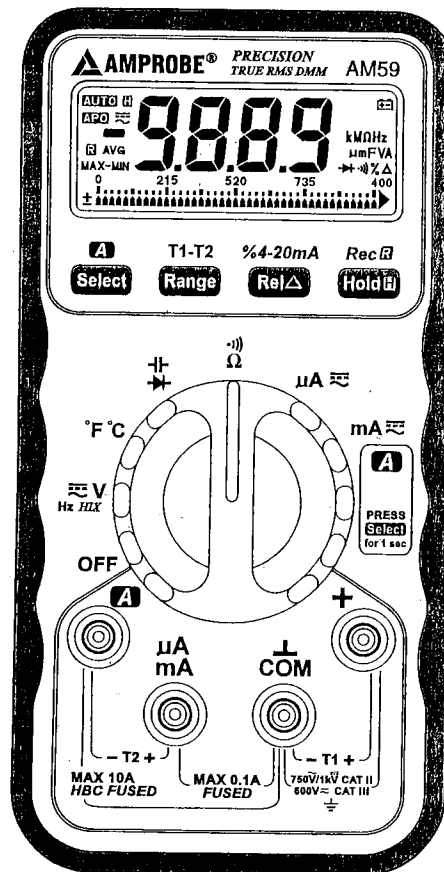

**USER'S
 MANUAL**

**AM-52
 AM-57
 AM-59**

AMPROBE®

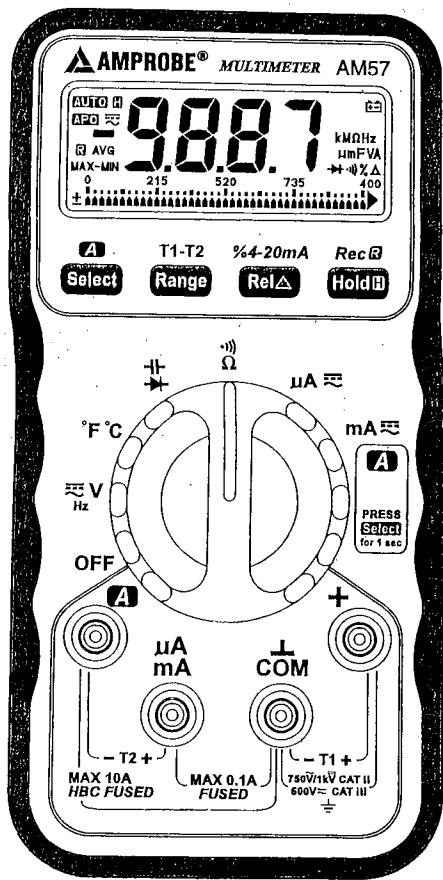



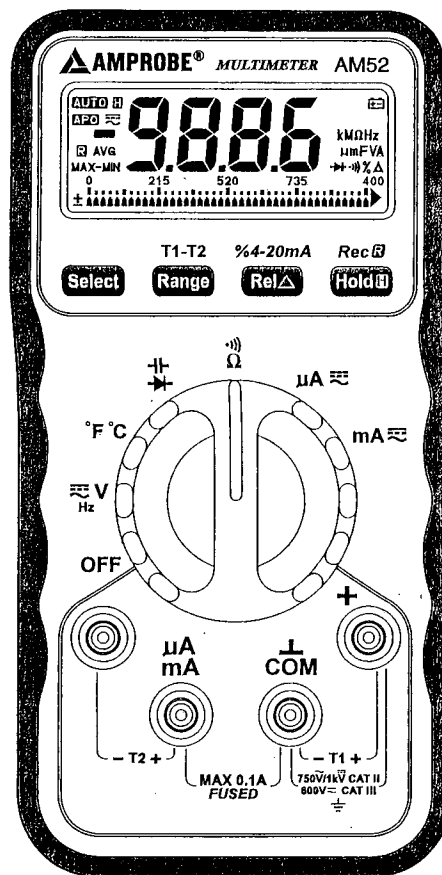



AM-57



AM-52

TABLE OF CONTENTS

1) SAFETY	1
2) INTRODUCTION	5
3) PRODUCT DESCRIPTION	6
3-1) Panel Illustration	6
3-2) LCD Illustration	8
3-3) Analog bar-graph	8
3-4) NMRR (Normal Mode Rejection Ratio)	10
3-5) CMRR (Common Mode Rejection Ratio)	10
3-6) Crest Factor	10
3-7) Average responding RMS calibrated	11
3-8) True RMS	11
3-9) Harmonics Index™ (HIX)	12
4) OPERATION	14
4-1) DCV, ACV, Hz*, & HIX(AM-59 only) functions	14
4-2) Temperature T1-T2 function	16
4-3)  Diode test function	18
4-4)  Capacitance function	20
4-5) Ω Resistance,  Continuity functions	22
4-6) μA, mA, %4-20mA functions	24
4-7)  function (AM-57 & AM-59 only)	26
4-8) Manual or Auto-ranging	26
4-9) ΔRelative mode	28
4-10) Hold 	28
4-11) Record  mode	28
4-12) Line filter frequency 50 Hz or 60 Hz selection	30
4-13) Power up default °C or °F selection	32
4-14) Auto Power Off (APO)	32
5) SPECIFICATIONS	33
6) MAINTENANCE	39
6-1) Battery Replacement Procedure	39
6-2) Fuse Replacement Procedure	41
6-3) Cleaning and Storage	41
6-4) Trouble Shooting	41









1) SAFETY

This manual contains information and warnings that must be followed for operating the instrument safely and maintaining the instrument in a safe operating condition. If the instrument is used in a manner not specified by the manufacturer, the protection provided by the instrument may be impaired.

TERMS IN THIS MANUAL

- WARNING** identifies conditions and actions that could result in serious injury or even death to the user.
- CAUTION** identifies conditions and actions that could cause damage or malfunction in the instrument.

INTERNATIONAL ELECTRICAL SYMBOLS

-  Caution ! Refer to the explanation in this Manual
-  Caution ! Risk of electric shock
-  Earth (Ground)
-  Double Insulation or Reinforced insulation
-  Fuse
-  AC Alternating Current
-  DC Direct Current
-  Both DC and AC

LETTER AND COLOR CODES FOR FUSES

- Very quick acting: FF, or black;
- quick acting: F, or red;
- medium time-lag: M, or yellow;
- time-lag: T, or blue;
- long time-lag: TT, or gray.

Safety: The instruments meet the requirements for double insulation, pollution degree 2 environment, to IEC1010-1(1995), EN 61010-1(1995), UL3111-1(6.1994), CSA C22.2 NO. 1010-1-92 to terminals:

V/R : Installation category III, 600V ac and dc
Installation category II, 750V ac and 1000V dc

mA/ μ A : Installation category III, 250 Volts ac.
Installation category II, 250 Volts dc.

A : Installation category III, 600 Volts ac.
Installation category II, 250 Volts dc.

E.M.C. : The instruments meet EN55022(1994/A1; 1995/Class B) and EN 50082-1(1992)

WARNING

To avoid electrical shock hazard or damage to the meter, do not exceed the overload protection shown in TABLE 1 below

FUNCTION	TERMINALS	OVERLOAD PROTECTION
DC VOLTAGE		
AC VOLTAGE	+ & COM	1000 V _{peak} or 780VAC rms
Hz FREQUENCY		
Ω RESISTANCE		
A) AUDIBLE CONTINUITY		
+ CAPACITANCE	+ & COM	600VDC or VAC rms
+ DIODE TEST		
TEMPERATURE T1		
TEMPERATURE T2	T2+ & T2-	0.16A/250V F Fuse
μ A mA CURRENT	μ A/mA & COM	0.16A/250V F Fuse
A CURRENT	A & COM	15A*/600V F Fuse

*10A continuous; 20A for 30 seconds maximum with 5 minutes cool down interval

TABLE 1

WARNING

To reduce the risk of fire or electric shock, do not expose this product to rain or moisture.

To avoid electrical shock hazard, observe the proper safety precautions when working with voltages above 60 VDC or 30 VAC rms. These voltage levels pose a potential shock hazard to the user. Do not touch test lead tips or the circuit being tested while power is applied to the circuit being measured. Keep your fingers behind the finger guards of the test leads during measurement.

Inspect test leads, connectors, and probes for damaged insulation or exposed metal before using the instrument. If any defects are found, replace them immediately.

Never attempt a voltage measurement with the test lead inserted into the μA , mA or **A** input jack. You might be injured or damage the meter.

Do not measure any circuit that draws more than the current rating of the protection fuse. Do not attempt a current measurement where the open circuit voltage is above fuse voltage rating. Suspected open circuit voltage can be checked with voltage functions. If the fuse blows, replace it with the proper fuse as specified in this manual. Failure to do so may result in injury or damage to the meter.

CAUTION

Disconnect the test leads from the test points before changing functions. Always set the instrument to the highest range and work downward for an unknown value if you are using manual ranging mode.

2) INTRODUCTION

The AM-50 series is hand held, battery operated professional quality digital multimeters for today's complex HVAC/R, industrial process control, electrical & electronic system diagnostic and troubleshooting.



The series includes AM-52, AM-57 & AM-59 models to provide different function combinations of DC Voltage, AC Voltage, True RMS, Harmonics index(HIX), T1-T2 Temperature, Frequency, Resistance, Continuity Test, Capacitance, Diode Test, DC Current as well as AC Current. This user's manual uses the top of the line model AM-59 as a representative for illustrations purposes. Please refer to your respective model for function availability for each model.

Pushbutton functions include T1-T2 differential temperature mode, %4-20mA industrial process control loop current percentage mode; Data Hold, Auto or Manual Ranging, Relative Zero mode, Record MAX/MIN/MAX-MIN/AVG as well as Secondary Functions Selection.

This series is housed inside a gasket sealed casing which keeps out grease, oil, dirt and moisture to maintain superb accuracy and reliability. Besides, the casing is made of high impact thick wall fire retarded material to maximize the durability of the meter, and safety to the user.

3) PRODUCT DESCRIPTION

3-1) Panel Illustration, See FIG 1

1. LCD display 4 digit 9999 counts LCD display
2. **Rec**  **Hold**  Pushbutton. Push momentarily to activate Hold, or Press and Hold for 1 second to activate RECORD function
3. **%4-20mA** **Rel**  **Δ** Pushbutton. Push momentarily to activate Relative Zero, or Press and Hold for 1 second to activate %4-20mA industrial process control loop current percentage mode function
4. **Selector** Turn the Power On or Off and Select a function
5. **+** Input Jack for all functions EXCEPT current & T2 functions
6. **COM** Common (Ground reference) Input Jack for all functions EXCEPT T2 function
7. **μA mA** Input Jack for μA mA current functions
8. **A** Input Jack for **A** current function
9. **Range** Pushbutton to select Auto or Manual ranging
10. **A** **Select** Pushbutton. Push momentarily to select secondary functions, or Press and Hold for 1 second to select **A** function

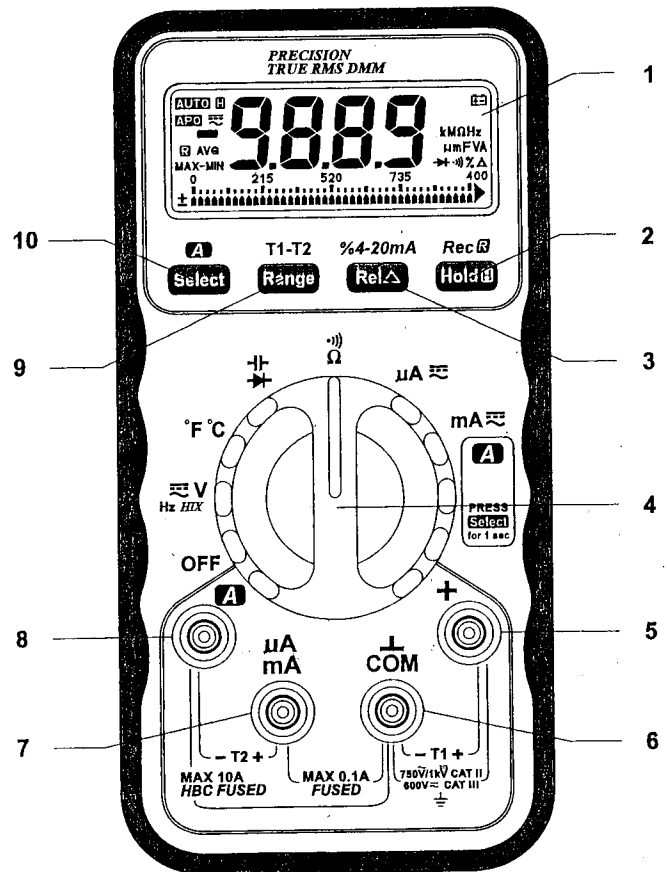











FIG 1. FRONT PANEL LAYOUT

3-2) LCD Illustration, See FIG 2

- 10.  Low Battery alert, replace the battery as soon as possible to ensure accuracy
- 11.  Δ annunciator indicates relative zero
- 12.  Analog bar graph with overload flag and polarity
- 13.  These annunciators indicate MAX (Maximum), MIN (Minimum), MAX-MIN (Maximum minus Minimum), or AVG (Average) reading is being displayed
- 14.  This annunciator indicates the RECORD function is activated
- 15.  This annunciator indicates Auto Power Off is enabled
- 16.  This annunciator indicates Auto-ranging
- 17.  This annunciator indicates data Hold function is activated
- 18.  ≡ annunciator indicates direct current (DC) is selected. ~ annunciator indicates alternating current (AC) is selected

3-3) Analog bar-graph

The analog bar graph provides a visual indication of measurement like a traditional analog meter needle. It is excellent in detecting faulty contacts, identifying potentiometer clicks, and indicating signal spikes during adjustments.

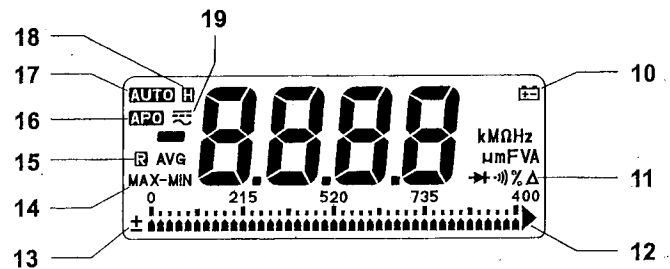

FIG 2. LCD DISPLAY (SHOWN ACTUAL SIZE)

3-4) NMRR (Normal Mode Rejection Ratio)

NMRR is the DMM's ability to reject unwanted AC noise effect which can cause inaccurate DC measurements.

NMRR is typically specified in terms of dB (decibel). AM-50 series has a NMRR specification of >50dB at 50 and 60Hz, which means a good ability to reject the effect of AC noise in DC measurements.

3-5) CMRR (Common Mode Rejection Ratio)

Common mode voltage is voltage present on both the COM and VOLTAGE input terminals of a DMM, with respect to ground. CMRR is the DMM's ability to reject common mode voltage effect which can cause digit rattle or offset in voltage measurements.

AM-50 series has a CMRR specifications of >60dB at DC to 60Hz in ACV function; and >100dB at DC, 50 and 60Hz in DCV function. If neither NMRR nor CMRR specification is specified, a DMM's performance will be uncertain.

3-6) Crest Factor

Crest Factor is the ratio of the Crest (instantaneous peak) value to the True RMS value. That is :

$$\text{Crest Factor} = \frac{V_{\text{crest}}}{V_{\text{rms}}}$$

A pure sinusoidal waveform has a Crest Factor of 1.414. A badly distorted sinusoidal waveform normally has a much higher Crest Factor. If you are measuring a signal above the DMM's specified Crest Factor, the DMM may not produce accurate measurements. The AM-59 can accurately measure the True RMS value of voltage signal with a Crest Factor up to 3.0 at full scale, and 6.0 at half scale.

3-7) Average responding RMS calibrated

RMS (Root-Mean-Square) is the term used to describe the effective or equivalent DC value of an AC signal. Most digital multimeters use average responding RMS calibrated technique to measure RMS values of AC signals. This technique is to obtain the average value by rectifying and filtering the AC signal. The average value is then scaled upward (calibrated) to read the RMS value of a sine wave.

In measuring pure sinusoidal waveform, this technique is cost effective and accurate. In measuring non-sinusoidal waveforms, however, significant errors can be introduced because of different scaling factors relating average to RMS values.

3-8) True RMS

True RMS is a term which identifies a DMM that responds accurately to the effective RMS value regardless of the waveform.

True RMS voltage is the effective voltage having the same heating value as a corresponding DC voltage. With True RMS voltage measurement, you can accurately measure the voltage values regardless of the waveforms such as: square, sawtooth, triangle, pulse trains, spikes, as well as distorted waveforms with the presence of harmonics. Harmonics may cause :

- 1) Overheated transformers, generators and motors to burn out faster than normal
- 2) Circuit breakers to trip prematurely
- 3) Fuses to blow
- 4) Neutrals to overheat due to triplen harmonics present on the neutral (150Hz or 180Hz)
- 5) Bus bars and electrical panels to vibrate

3-9) Harmonics Index™ (HIX)

Harmonics are unwanted AC voltages or currents with frequencies that are multiples of the fundamental frequency, which produce non-sinusoidal waveforms. Harmonic currents are typically caused by solid state lighting ballasts, solenoids, motor controllers, switching power supplies or any other nonlinear load. Harmonics normally appear in the current waveforms, however, the current harmonics can distort the system voltage waveform and cause voltage harmonics when the system impedance is relatively high. These voltage harmonics will then affect other devices within the same system.

In the past, to identify the presence of harmonics which cause problems to your system, you may need an expensive instrument to see the complete harmonic spectrum with respect to fundamental frequency. Now, harmonics index™ (HIX) function offers an alternative to indicate the presence of harmonics by a hand held digital multimeter in a cost effective way.

Harmonics Index™ (HIX) function generates a comparative percentage index between 0% to 100% to indicate the deviation of non-sinusoidal to sinusoidal waveform, which is a good indication of the presence of harmonics. Pure sinusoidal waveform without harmonics has a harmonics index™ value of 0%. The higher the harmonics index™ value, the more the harmonics are present. Harmonics index™ value examples are given in table 2 for your reference. Please note that in cases where the harmonics are mostly 3rd (triplen), the neutral current can be a nearly pure sine wave at the harmonic frequency of 150Hz or 180Hz (triplen) which can often be detected by measuring the frequency of the neutral current.

INPUT WAVEFORM	DESCRIPTION	HIX VALUE
	a) No distortion, pure sinusoidal, $y=100\sin(\omega t)$	0%
	b) Fundamental with 10% 3rd harmonics, $y=100\sin(\omega t) + 10\sin(3\omega t+\pi)$	4%
	c) Fundamental with 20% 3rd harmonics, $y=100\sin(\omega t) + 20\sin(3\omega t+\pi)$	8%
	d) Fundamental with 30% 3rd harmonics, $y=100\sin(\omega t) + 30\sin(3\omega t+\pi)$	13%
	e) Fundamental with 40% 3rd harmonics, $y=100\sin(\omega t) + 40\sin(3\omega t+\pi)$	17%
	f) Fundamental with 50% 3rd harmonics, $y=100\sin(\omega t) + 50\sin(3\omega t+\pi)$	19%

TABLE 2. HARMONICS INDEX™ VALUE EXAMPLE

4) OPERATION

4-1) DCV, ACV, Hz*, & HIX (AM-59 only) functions

- 1) Set rotary switch to $\overline{\text{V}}$ position
- 2) Default at DC. Press **Select** button momentarily to select AC, Hz, or HIX (AM-59 only) when required
- 3) Insert red (+) test lead into + jack and black (-) test lead into **COM** input jack
- 4) Connect test leads to voltage source and observe the digital display. See **FIG 3**

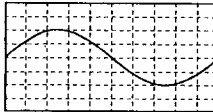
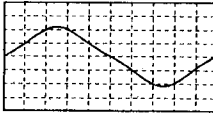
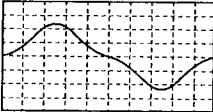
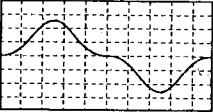
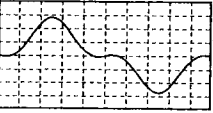
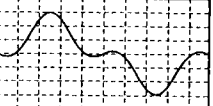
*Note: 1. 4 trigger levels selectable through the **Range** push button for advanced applications in this Hz function. Trigger level 1 is the highest sensitivity, and trigger level 4 is the lowest sensitivity. The LCD bargraph pointer will point at the selected trigger level scale 1, 2, 3, or 4. Press the **Range** button momentarily to select another trigger level. Power up default trigger level is set at level 1 for highest sensitivity. If the Hz reading becomes unstable, select higher trigger level (lower sensitivity) to avoid electrical noise. If the reading shows zero, select lower trigger level (higher sensitivity).

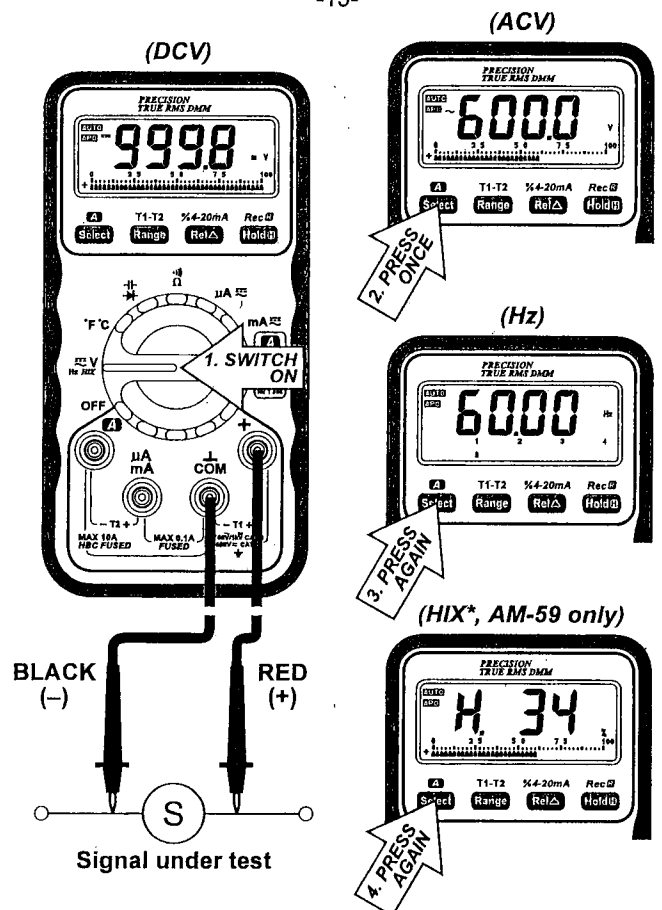

*Note: In HIX function, the analog bargraph displays ACV levels.

FIG 3. DCV, ACV, Hz, & HIX* (AM-59 only) FUNCTIONS

4-2) Temperature T1-T2 function

- 1) Set rotary switch to °C/°F position
- 2) Press Select button momentarily to toggle between °C and °F readings. Power up default can be set at °C or °F as power up option. See section (4-13) Power up default °C or °F selection for more details
- 3) Insert banana plug K-type temperature bead probe (optional accessory) with positive (+) plug into T1+ (+jack) and negative (-) plug into T1- (COM) input jack for T1 measurement; and with positive (+) plug into T2+ ($\mu A/mA$) input jack and negative (-) plug into T2- (A) input jack for T2 measurement. You can also use a plug adapter (optional accessory) with banana pins to K-type socket to adapt the standard K type mini plug temperature probe
- 4) Touch the end of the thermo-probe(s) to the measurement surface(s) and observe the digital display, see **FIG 4**
- 5) Default at T1. Press T1-T2 (Range) button momentarily to select T1, T2, or T1-T2 readings. The LCD bargraph pointer will indicate the mode selected.

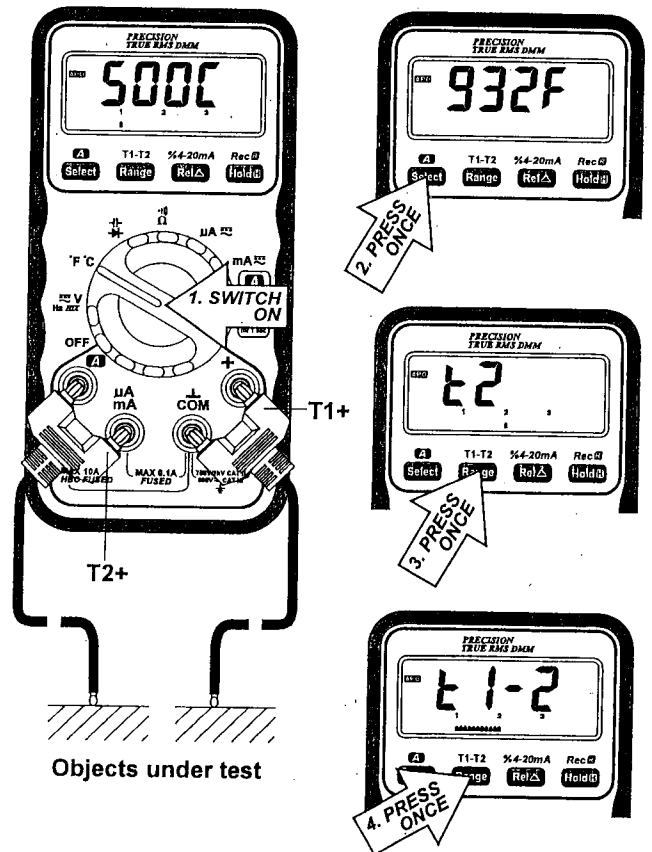

FIG 4. TEMPERATURE T1-T2 FUNCTION

4-3) \rightarrow Diode test function

- 1) Set rotary switch to \rightarrow
- 2) Insert red (+) test lead into +jack and black (-) test lead into COM input jack
- 3) Connect the test leads as shown in **FIG 5** and observe the digital display
- 4) Normal forward voltage drop (forward biased) for a good silicon diode is between 0.400V to 0.900V. A reading higher than that indicates a leaky diode (defective). A zero reading indicates a shorted diode (defective). An OL indicates an open diode (defective)
- 5) Reverse the test leads connections (reverse biased) across the diode
- 6) The digital display shows OL if the diode is good. Any other readings indicate the diode is resistive or shorted (defective)

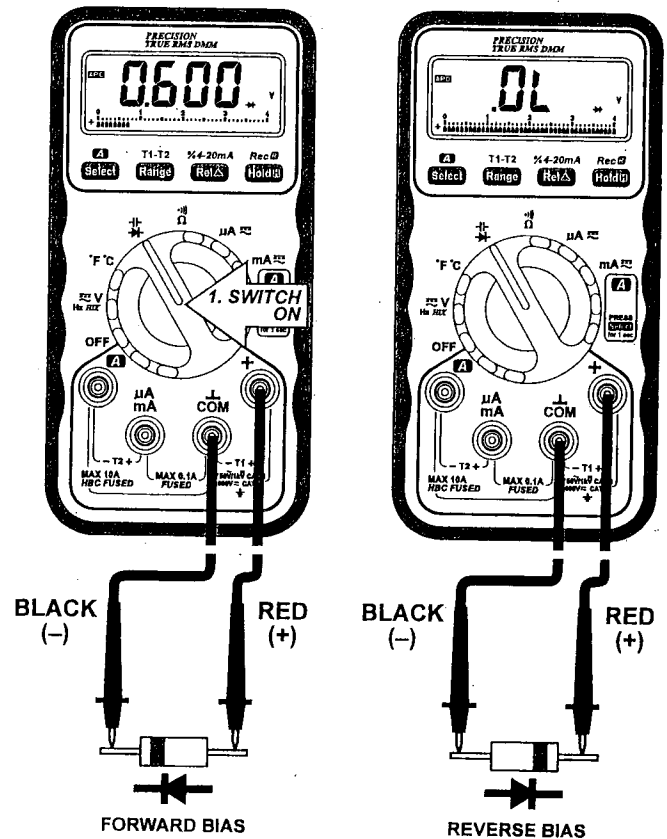

FIG 5. \rightarrow DIODE TEST FUNCTION

4-4) $\text{--}\text{||}\text{--}$ Capacitance function

- 1) Set rotary switch to $\text{--}\text{||}\text{--}$
- 2) Default at $\text{--}\text{||}\text{--}$ diode. Press **Select** button momentarily to select $\text{--}\text{||}\text{--}$ capacitance
- 3) Insert red (+) test lead into + jack and black (-) test lead into **COM** input jack
- 4) Connect the test leads as shown in **FIG 6** and observe the digital display

CAUTION

Discharge capacitors before making any measurement. Large value capacitors should be discharged through an appropriate resistance load

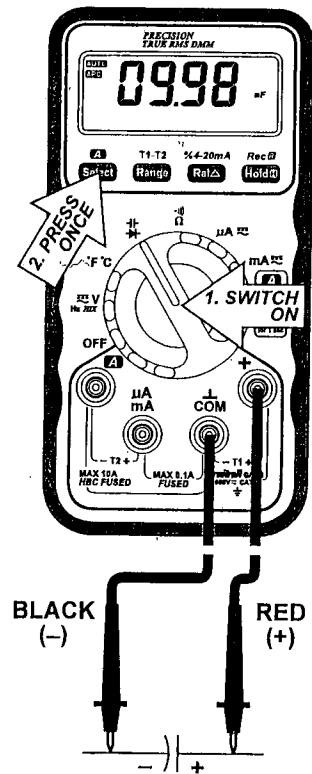

FIG 6. $\text{--}\text{||}\text{--}$ CAPACITANCE FUNCTION

4-5) Ω Resistance, \bullet) Continuity functions

- 1) Set rotary switch to $\Omega \bullet$)
- 2) Insert red (+) test lead into + jack and black (-) test lead into COM input jack
- 3) Connect the test leads as shown in FIG 7 and observe the digital display
- 4) Default at Ω . Press Select button momentarily to select \bullet) Continuity function
- 5) A continuous beep tone indicates a complete wire. This is useful for checking wiring connections and operation of switches

CAUTION

Using resistance measurement function in a live circuit will produce false results and may damage the instrument. In many cases the suspect component must be disconnected from the circuit to obtain an accurate reading

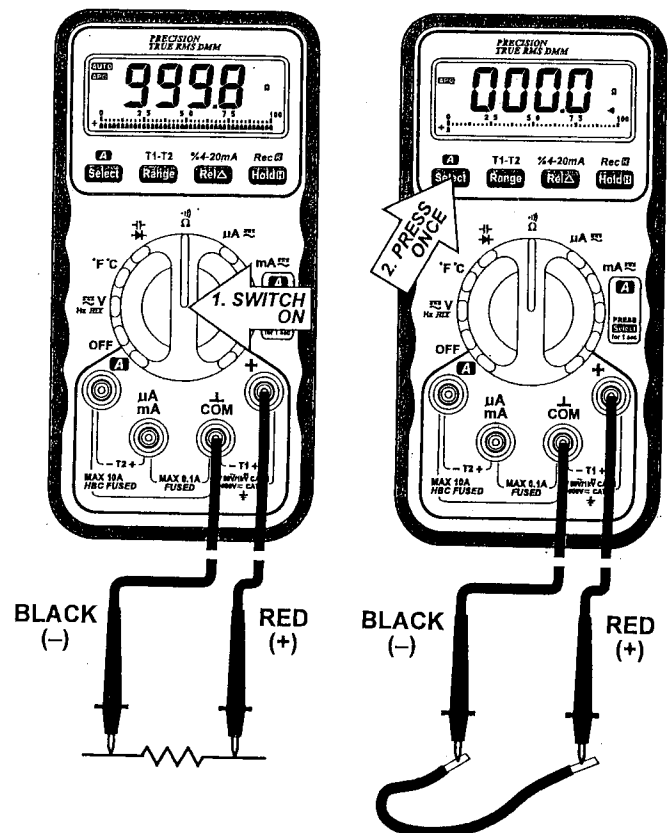

FIG 7. Ω RESISTANCE, \bullet) CONTINUITY FUNCTIONS

4-6) μA , mA, %4-20mA functions

- 1) Set rotary switch to μA or mA as required
- 2) Insert red (+) test lead into μA /mA jack and black (-) test lead into COM input jack
- 3) Default at DC. Press Select button momentarily to select AC
- 4) Connect the test leads as shown in FIG 8 and observe the digital display
- 5) In DC mA function, press and hold the %4-20mA (Rel Δ) button for 1 second or more to display the loop current % value

Application notes:

- 1) The DC μA function supports unparalleled accuracy & resolution of $0.01 \mu A$ up to $40 \mu A$ which is especially useful for identifying the minute current changes in flame detector applications. Flame signal current check should indicate steady flame signal of at least $2 \mu A$ for a rectification type, or $1.5 \mu A$ for an ultraviolet type ($8 \mu A$ for self checking systems). If a flame signal current with inadequate strength or fluctuation beyond 10% (from $0.15 \mu A$), check the following to avoid the risk of unwanted flame relay dropout:

1-1) For gas or oil flames (Minipeeper):

- Low supply voltage
- Detector location
- Defective detector wiring
- Dirty viewing windows
- Faulty Minipeeper

1-2) For oil flames (Photocell):

- Detector location & wiring
- Smoky flame or poorly adjusted air shutter
- Faulty Photocell
- Temperature over 165 F (74 C) at photocell

1-3) For gas flames (Flame Rod):

- Ignition interference (A flame signal current difference with the ignition both on and off greater than $0.5 \mu A$ indicates the presence of ignition interference)
- Insufficient ground (must be at least 4 times the detector area)
- Flame lifting off burner head (ground), or not continuously in contact with the flame rod

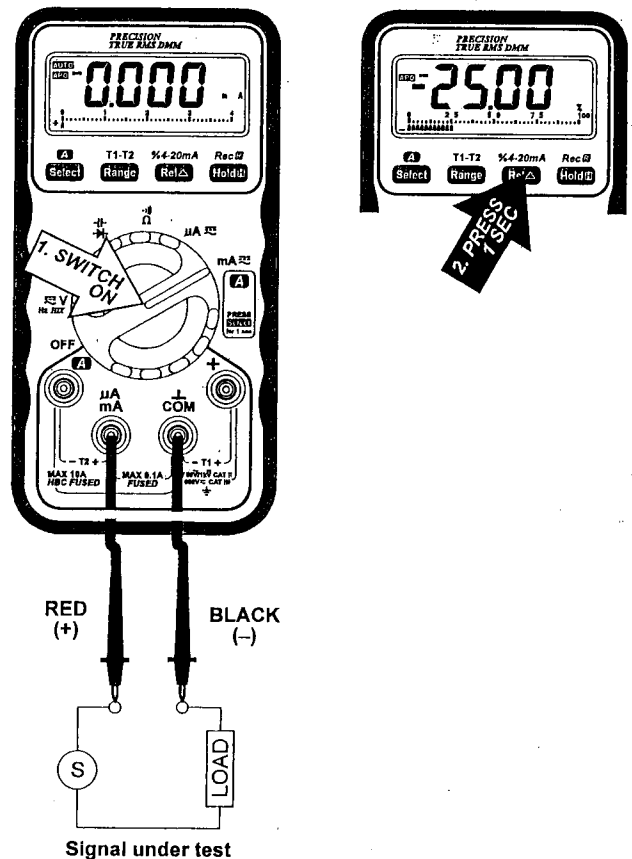

FIG 8. μA , mA, %4-20mA FUNCTION

- Temperature in excess of 600 F (316 C) at the flame electrode insulator causing short to ground.
- 2) The DC mA function supports superb resolutions of 0.001mA (1 μ A) up to 4mA and 0.01mA (10 μ A) up to 40mA. Press and hold the %4-20mA (Rel Δ) button for 1 second or more can further display the DC mA value in terms of loop current % value as commonly used in the industrial process control applications. The loop current % value is set at 4mA = 0% (zero) and 20mA = 100% (span) with 0.01% high resolution, which virtually extends the meters' capability to test and regulate the externally powered loop current in the industrial process control applications. AM-59 further supports a calibration level accuracy of 0.05% in 40mA range, which allows you to monitor any lower level loop current source and turn it into a calibrator level loop current source

4-7) **A** function (AM-57 & AM-59 only)

- 1) Set rotary switch to mA **A**
- 2) Default at mA which will **NOT** auto-range to **A** function. The user **MUST** press and hold the Select button for 1 second or more to toggle to **A** function. Failure to do so will lead to incorrect reading in misleading mA unit
- 3) Insert red (+) test lead into **A** jack and black (-) test lead into COM input jack
- 4) Default at DC. Press Select button momentarily to select AC
- 5) Connect the test leads as shown in **FIG 9** and observe the digital display

4-8) Manual or Auto-ranging

Press the Range button momentarily to select manual-ranging, and the meter will remain in the range it was in, the LCD annunciator **AUTO** turns off. Press the button momentarily again to step through the ranges. Press and hold the button for 1 second or more to resume auto-ranging. Note : When the meter is in Record, Hold, or Relative mode, changing the measuring range manually will cause the meter to exit those features

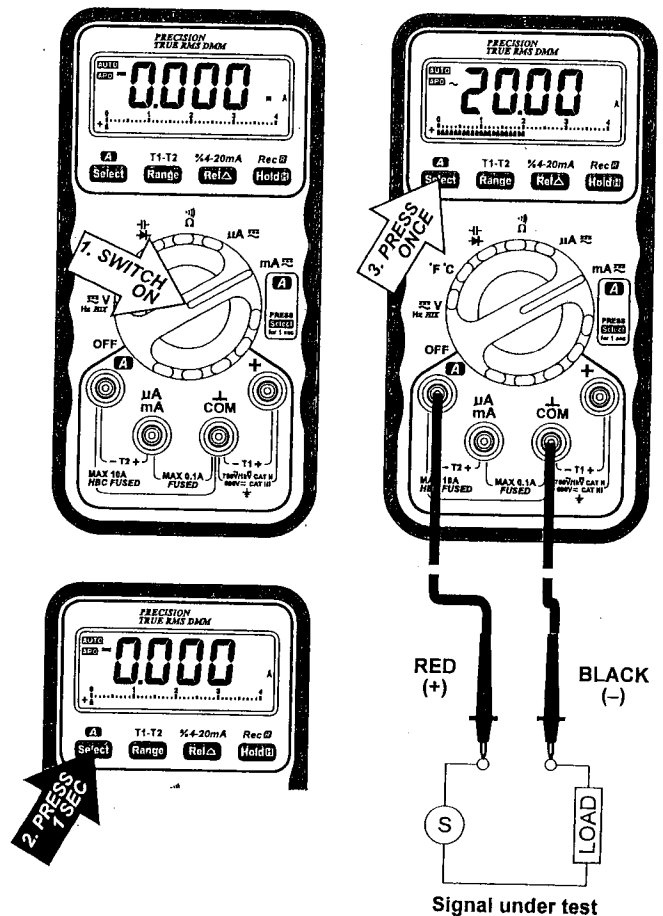

FIG 9. A FUNCTION (AM-57 & AM-59 only)

4-9) Δ Relative mode

Press the **Rel Δ** button momentarily to enter the Relative Zero (Δ) mode, the LCD annunciator Δ turns on. Relative zero allows the user to offset the meter measurements with a relative reference value. Practically all displaying readings can be set as relative reference value including MAX, MIN, MAX-MIN, and AVG readings of RECORD function

Press the Δ button again to exit relative mode and resume normal measurements

4-10) Hold \square

The hold function freezes the display for later view. Press the **Hold \square** button momentarily to activate the hold function, the LCD annunciator \square turns on. Press momentarily again to release.

4-11) Record \square mode

Press and hold the **Rec \square** button for 1 second or more to activate RECORD mode, the LCD annunciators \square AVG, \square MAX-MIN turn on. The meter beeps when new maximum or minimum reading is updated. Press the button momentarily to read throughout the Maximum (MAX), Minimum (MIN), Maximum minus Minimum (MAX - MIN), and Average (AVG) readings. Press the button for 1 second or more to exit RECORD mode. See **FIG 10**

FIG 10

With the RECORD in Auto-Ranging mode, you can easily track intermittent signals, capture turn-on/turn-off surges, and monitor line voltage changes over a much wider dynamic range with the best resolution. It largely

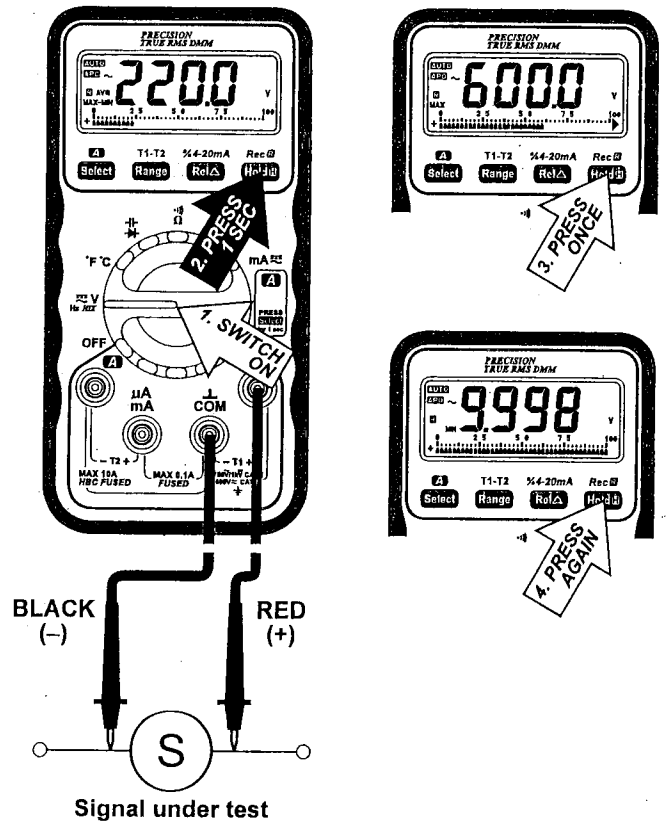

FIG 10. RECORD FUNCTION

surpasses competitors' single manual-ranging recording which is easily over-flowed, or with insufficient resolution. The meter features a fast single range sampling speed of 50ms for MAX, MIN, MAX-MIN and AVG readings. The faster the sampling speed, the more accurate the measurement of surges, spikes and sags will be. The true average AVG feature calculates all readings taken over time continually (mathematical integral), and is defined as the summation of readings taken divided by the number of reading counted from the instant that the RECORD mode is activated up to the instant when the AVG reading is displayed.

Note: 1. Auto Power Off feature will be disabled automatically in this mode

4-12) Line filter frequency 50 Hz or 60 Hz selection

The line filter frequency can be selected as a power-on option. Press the **Select** button while turning the meter on to display the set frequency. Press the **Range** button for 50 Hz or press the **Rel Δ** button for 60 Hz selection. Then press the **Hold** button to store the selected frequency. See **FIG 11**

Selecting the appropriate line filter frequency to cope with your line frequency can maximize the meter's noise rejection ability. This is normally only available in expensive bench top multimeter

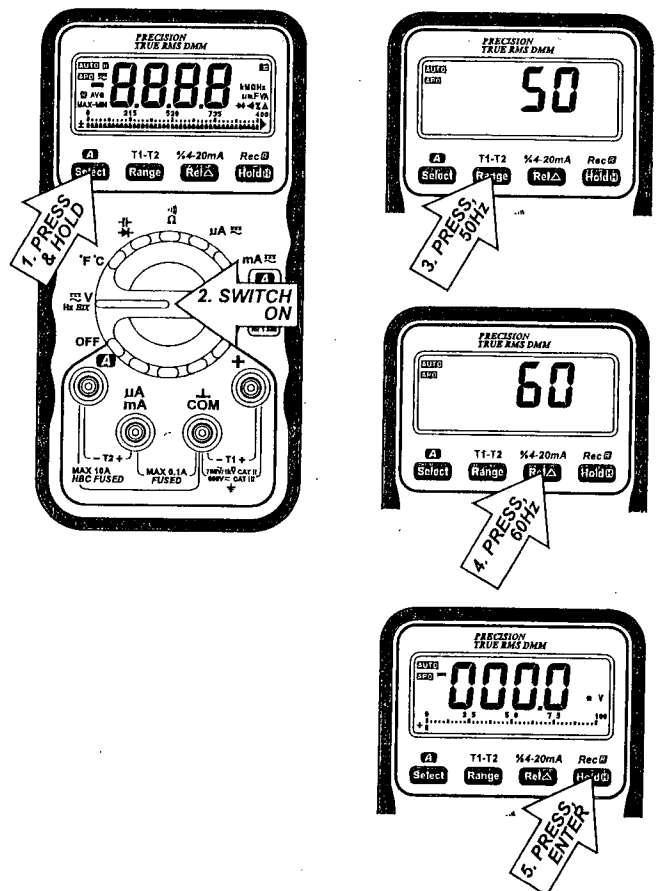

FIG 11. LINE FREQUENCY SELECTION

4-13) Power up default °C or °F selection

Power up default °C or °F reading can be selected as a power-on option in a similar manner as described in section (4-12). Press the **Rel** Δ button while turning the meter on to display the set °C or °F. Press the **Range** button for °C or press the **Rel** Δ button for °F selection. Then press the **Hold** \square button to store the selected setting.

4-14) Auto Power Off (APO)

The Auto Power Off (APO) mode turns the meter off automatically to extend battery life after approx. 17 minutes of no activities. The meter turns back on if the rotary switch is turned. Activities are specified as :

- 1) Rotary switch or push button operations
- 2) Significant measuring data readings

When the meter is under normal measurements, it will intelligently avoid entering the APO mode

When the meter enters the RECORD mode, the Auto Power Off will be disabled automatically, and the LCD annunciator **APO** will be off

Note: 1. Always turn the rotary switch to the OFF position when the meter is not in use

5) SPECIFICATIONS

GENERAL SPECIFICATIONS

Display : 4 digits 9999 counts LCD

Polarity : Automatic

Update Rate :

Data: 4 per second nominal;

42 Segments Bar graph: 20 per second max

Low Battery: Low battery indicator appears when the battery voltage drops below approx. 7.2VDC

Operating Temperature : 0°C to 35°C, 0-80% R.H.; 35°C to 40°C, 0-70% R.H.

Storage Temperature : -20°C to 55°C, 0-80% R.H. (with battery removed)

Temperature Coefficient : nominal 0.15 x (specified accuracy)/°C @ 0°C-18°C or 28°C-40°C

Power Supply : Single 9V battery; NEDA1604, JIS006P or IEC6F22

APO Timing : Idle for approx. 17 minutes

APO Consumption : 30 μ A Typical

Overload Protections :

V: 1000V_{peak}/780V_{VAC rms};

A: 15A/600V HBC F Fuse, IR 100kA (AMPROBE NO. KLK 15);
 μ A, mA, & T2: 0.16A/250V F Fuse, IR 1.5kA (AMPROBE NO. 5X20-216.160);

Others: 600VDC/VAC rms

Safety: The instruments meet the requirements for double insulation, pollution degree 2 environment, to IEC1010-1(1995), EN 61010-1(1995), UL3111-1(6.1994), CSA C22.2 NO. 1010-1-92 to:
terminal V/R: Installation category III, 600V ac and dc
Installation category II, 750V ac and 1000V dc

terminal mA/μA: Installation category III, 250 Volts ac.
 Installation category II, 250 Volts dc.
 terminal A: (AM-57 & AM-59 only)
 Installation category III, 600 Volts ac.
 Installation category II, 250 Volts dc.

E.M.C. : Meets EN55022(1994/A1;1995/Class B) and EN50082-1(1992)

Sensing : True RMS for AM-59; Average responding for AM-57 & AM-52

Dimension : L5.85" (150mm) X W2.9"(75mm) X H1.3"(34mm) (without holster); L6.24"(160mm) X W3.2"(82mm) X H1.9"(48mm) (with holster)

Weight : approx. 0.55lb(252 gm) (without holster); approx. 0.76lb(345 gm) (with holster)

Power Consumption : 3.5 mA Typical

Accessories : Test leads (pair), battery installed and user's manual
Special Features : T1-T2 Temperature measurement, Percentage of 4mA~20mA Loop Current Measurement, Auto-ranging Record (Max, Min, Max-Min, Avg), Auto-ranging Relative (Zero), and Data Hold,

ELECTRICAL SPECIFICATIONS

Accuracy is ± (% reading digits + number of digits) or otherwise specified, at 23°C± 5°C & less than R.H. 75%.

DC Voltage

Range	AM-52	AM-57	AM-59
	Accuracy		
999.9 mV, 9.999 V, 99.99 V		0.15%+3d	
999.9 V		0.4%+5d	

NMRR : > 50dB @ 50/60Hz
 CMRR : > 100dB @ DC, 50/60Hz, Rs=1kΩ
 Input Impedance : 10MΩ, 30pF nominal (16MΩ nominal for 999.9mV range)

AC Voltage

Range	AM-52	AM-57	AM-59*
	Accuracy		
50Hz — 200Hz			
999.9mV		2.5% + 8d	
50Hz — 500Hz			
9.999V, 99.99V, 750.0V		1.25% + 3d	1.1% + 3d
500Hz — 2kHz			
9.999V, 99.99V, 750.0V		Unspec'd	1.8% + 3d**

CMRR : > 60dB @ DC to 60Hz, Rs=1kΩ

Input Impedance : 10MΩ, 30pF nominal (16MΩ nominal for 999.9mV range)

Trms Crest factor : < 3:1 at full scale, and < 6:1 at half scale

*True RMS Specified from 5% to 100% of range

**True RMS Specified from 10% to 100% of range

Harmonics Index™ HIX (AM-59 only)

Range	0.0% to 99.9%
Input Voltage	30mVAC to 750VAC

DC Current

Range	AM-52	AM-57	AM-59
	Accuracy		
40.00 μ A	0.3% + 4d		0.25% + 3d
400.0 μ A	0.2% + 3d		0.15% + 2d
4.000mA	0.3% + 4d		0.25% + 3d
40.00mA	0.2% + 3d		0.05% + 3d
4.000A	N/A	0.6% + 4d	0.5% + 4d
10.00A*	N/A	0.4% + 3d	0.3% + 3d

*10A Continuous; 20A for 30 Second Max with 5 minutes cool down interval

AC Current

Range	AM-52	AM-57	AM-59*
	Accuracy		
50Hz — 500Hz			
400.0 μ A	1.2% + 3d		1.0% + 3d
40.00mA	1.2% + 3d		1.0% + 3d
10.00A***	N/A	1.2% + 4d	1.0% + 4d**
500Hz — 2kHz			
400.0 μ A	1.8% + 3d		1.5% + 3d
40.00mA	1.8% + 3d		1.5% + 3d
10.00A***	N/A	1.8% + 4d	1.5% + 4d**

*True RMS Specified from 10% to 100% of range

**True RMS Specified from 25% to 100% of range

***10A Continuous; 20A for 30 Second Max with 5 minutes cool down interval

Ohms

Range	AM-52	AM-57	AM-59
	Accuracy		
999.9 Ω	0.5%+5d		
9.999k Ω , 99.99k Ω	0.5%+2d		
999.9k Ω , 4.000M Ω	0.8%+2d		
40.00M Ω	1.5%+2d		

Open Circuit Voltage : Typical 1.3VDC (2.7VDC @ 999.9 Ω Range)

Capacitance

Range	AM-52	AM-57	AM-59
	Accuracy*		
1.000 μ F	1.0% + 4d		
10.00 μ F	1.0% + 3d		
100.0 μ F	1.2% + 3d		
1.000mF	1.5% + 4d		
10.00mF	4.0% + 5d		

* Accuracies with film capacitors, or capacitors that have negligible dielectric absorption

Frequency

Range	AM-52	AM-57	AM-59
	Accuracy		
9.999Hz, 99.99Hz, 999.9Hz, 9.999kHz, 50.00kHz	0.05%+4d		

4 selectable trigger levels 1, 2, 3, and 4 (by Range button)

Input Signal : Sine wave, or Square wave with duty cycle >40% & <70%

Temperature T1 & T2

Range	AM-52	AM-57	AM-59
	Accuracy		
-20°C to 300°C / 0°F to 572°F	± (3°C+1d) / ± (6°F+2d)		
301°C to 500°C / 573°F to 932°F	± (2%+1d) / ± (2%+2d)		

Sensor : "K" Type Thermocouple, sensor accuracy not included

Temperature Coefficient : nominal 0.2 x (specified accuracy)/°C @ 0°C
-18°C or 28°C-40°C

✦ **Diode Tester Temperature Coefficient** : nominal 0.15 x
(specified accuracy)/°C @ 0°C-18°C or 28°C-40°C

Range	Test Current (Typical)	Open Circuit Voltage
2.000V	0.5mA	< 3.5 VDC

•)) **Audible Continuity Tester**

Audible threshold : the beeper sounds if the measured resistance is lower than 10 Ω, and turns off when greater than 200 Ω. Response time < 150 μs

6) MAINTENANCE

WARNING

To avoid electrical shock, remove test leads and any input signals before opening the case. Do not operate with open case. Install only the same type of fuse or equivalent

6-1) Battery replacement procedure

When the battery symbol  on the display is on, replace the battery as soon as possible to ensure accuracy. The meter uses a single standard 9V battery (NEDA1604, JIS006P, IEC6F22)

- 1) Disconnect the meter from any circuit and remove the test leads from the input jacks
- 2) Turn the meter OFF
- 3) Loosen the three captive screws from the case bottom
- 4) Lift the end of the case bottom nearest the input jacks until it unsnaps from the case top, see [FIG 12](#)
- 5) Disconnect the battery from the battery connector
- 6) Snap the battery connector to the terminals of the replacement battery. Dress the battery leads so that they are properly seated and will not be pinched between the case top and case bottom
- 7) Replace the case bottom, ensuring that all the gaskets are properly seated and the two snaps on the case top (near the LCD side) are engaged
- 8) Re-fasten the 3 captive screws

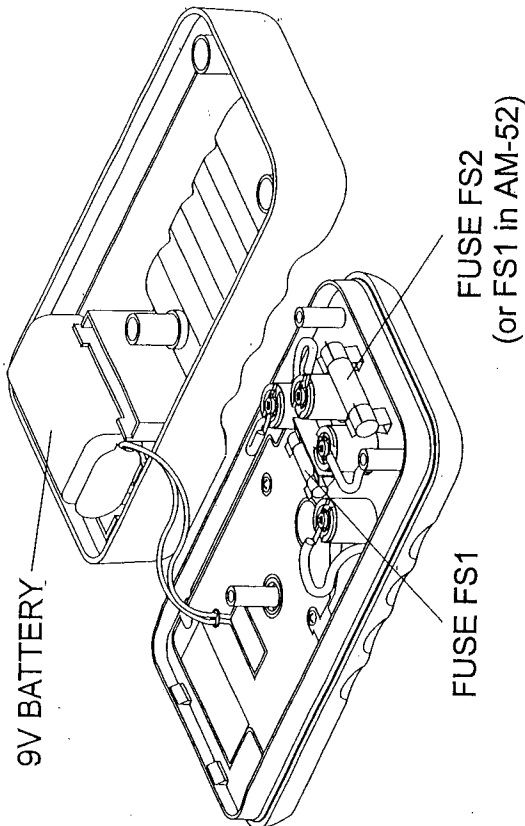

FIG 12. BATTERY & FUSE REPLACEMENT

6-2) Fuse replacement procedure

The meter uses a 250V/0.16A IR 1.5kA fast acting fuse (FUSE 1) for μ A/mA current & T2 input, and a 600V/15A IR 100kA fast acting fuse (FUSE 2) for Δ current input

- 1) Perform steps 1) through 4) of the battery replacement procedure
- 2) Replace the blown fuse(s)
- 3) Perform step 7) through 8) of the battery replacement procedure

6-3) Cleaning and Storage

Periodically wipe the case with a damp cloth and mild detergent; do not use abrasives or solvents. If the meter is not to be used for periods of longer than 60 days, remove the battery and store it separately

6-4) Trouble Shooting

If the instrument fails to operate, check battery, fuses, leads, etc., and replace as necessary. Double check operating procedure as described in this user's manual

If the instrument voltage / resistance input terminal has subjected to high voltage transient (can be up to several thousand volts) by accident or abnormal conditions of operation, the series fusible resistors will be blown off (become high impedance) like fuses to block further damages to the instrument. Most measuring functions through this terminal will then be open circuit. The series fusible resistors and the spark gaps should then be replaced by qualified technician.

Refer to the LIMITED WARRANTY section for obtaining warranty service or repairing service